

DUAL DIGITAL CONTROLS

Control temperature, time, chromotherapy and reading lights inside or outside your sauna with dual redundant controls.

ELEGANT DETAILS

Beautiful tongue and groove wood and attention to detail set our furniture quality sauna cabins apart.

LOW EMF / LOW ELF

The safest and most effective saunas available with Ultra Low EMF / Low ELF technology.

BEAUTIFUL ACCENT LIGHTS

Energy efficient LED lights highlight the beauty of your sauna while providing gentle ambient lighting.

THERAPEUTIC FAR INFRARED HEATERS

Our exclusive True Wave™ hybrid Carbon & Ceramic low EMF far infrared heaters surround you in healing infrared heat.



ENHANCED AUDIO SOUND SYSTEM



Bluetooth and AUX inputs make it easy to connect and listen to your audio devices.

360° HEAT



360° heat to effectively heat your core.

STRONG CONSTRUCTION



Strong and sturdy construction with a traditional look.

EXCLUSIVE UNDER FLOOR HEATER



Only Clearlight Essential Saunas include a heater underneath the ceramic floor to enhance your sauna session.

SPECIFICATIONS

Construction

Eco Certified Grade "A" clear Hypoallergenic Nordic Spruce
6 mm safety glass
Weight: 175 kg

Exterior

Width: 127 cm
Depth: 112 cm
Height: 195 cm

Interior

Width: 117 cm
Depth: 102 cm
Height: 170 cm
Bench: 115 cm x 51 cm

Far Infrared Heaters

True Wave™ Carbon & Ceramic Low EMF/ELF Heaters
Power: 230 V / 1,750 W / 8A

Full Lifetime Warranty

Comes with standard chromotherapy, upgrade possible.

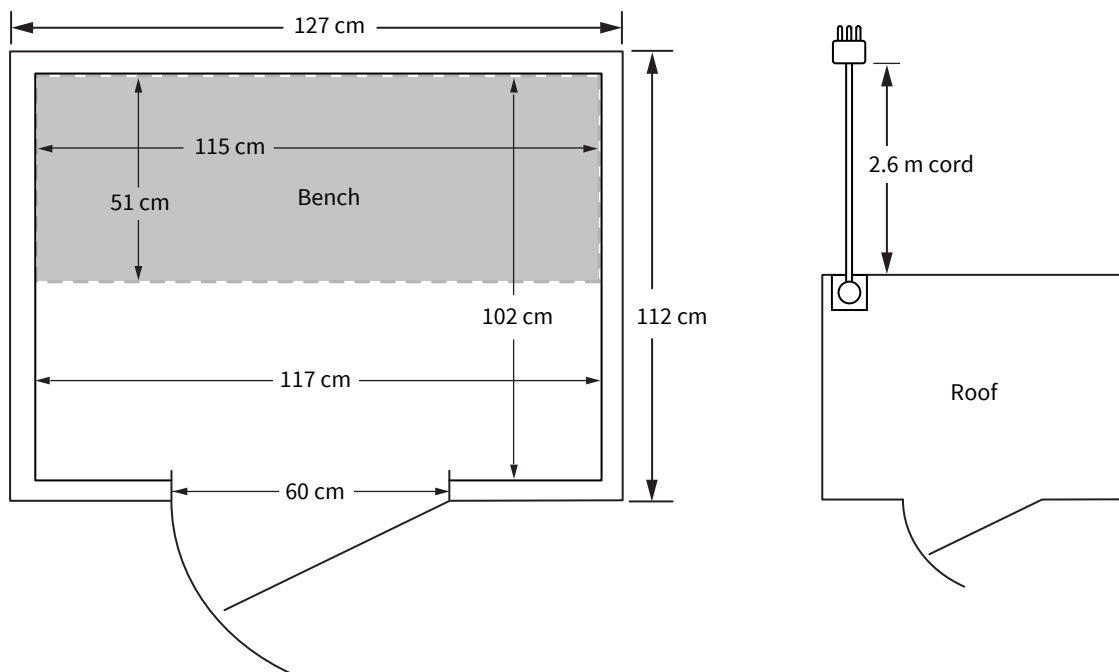
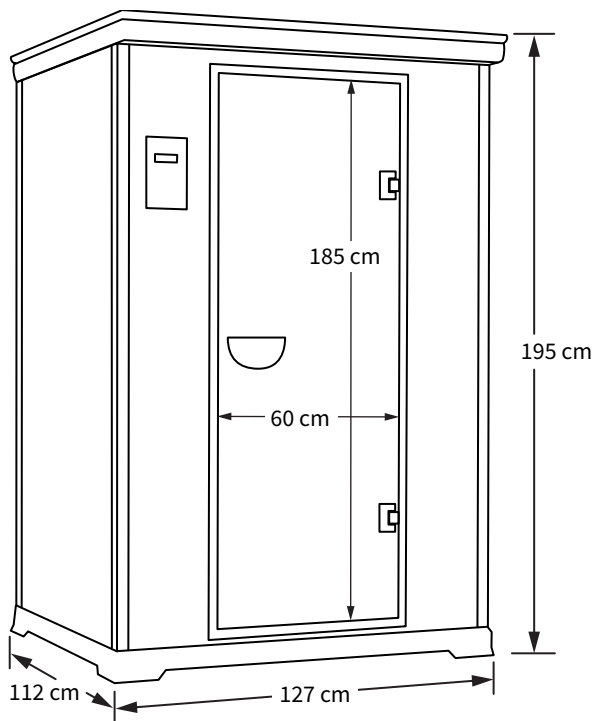

SPECIFICATIONS

Construction

Eco Certified Grade "A" clear
Hypoallergenic Nordic Spruce
6 mm safety glass
Weight: 175 kg

Exterior

Width: 127 cm
Depth: 112 cm
Height: 195 cm

Interior

Width: 117 cm
Depth: 102 cm
Height: 170 cm
Bench: 115 cm x 51 cm

Far Infrared Heaters

True Wave™ Carbon & Ceramic
Low EMF/ELF Heaters
Power: 230 V / 1,750 W / 8A

Full Lifetime Warranty

Comes with standard
chromotherapy,
upgrade possible.