



# RADIATION DOSIMETER

# RADEX ONE

## USER MANUAL

Radiation dosimeter (radioactivity indicator) is designed to measure ambient ionized radiation types Beta, Gamma and X-ray, radioactivity of materials and products, as well as the radiation dose received.

### DISPLAY TYPE

Icons 6 and 7 are visible when these functions are active.

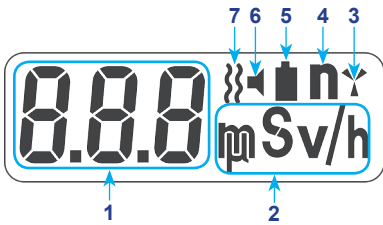

1. Measurement result
2. Measurement units
3. Quanta (particle) indicator  $\gamma$  flashes every time ionized particle is registered by the sensor. If the icon is constantly on, the measurements exceed specified threshold level.
4. Margin of error is minimal
5. The batteries need to be replaced
6. Audio alarm is ON
7. Vibration alarm is ON

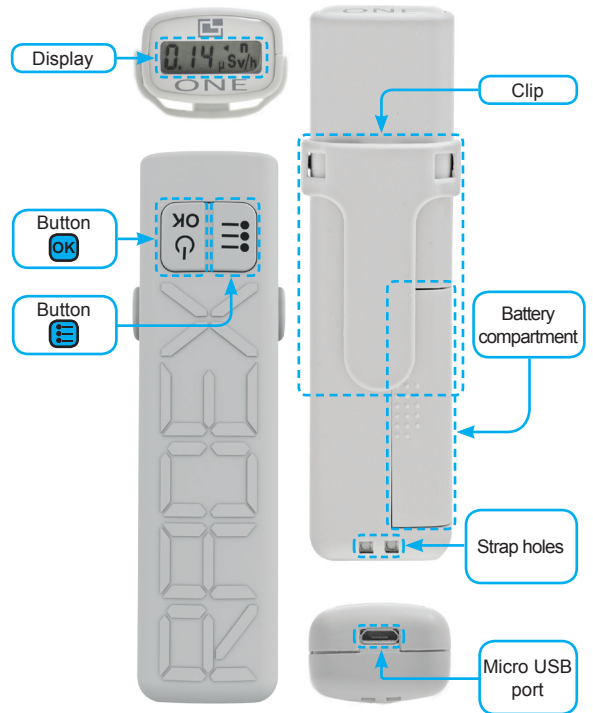

## INSTALLING BATTERIES

1. Open the battery compartment cover on the back of the device.
2. Insert one AAA battery.
3. Close the battery compartment.



## Using RADEX ONE

### Turning on

Press **OK** to turn on Diagnostic Mode.



### Taking measurements

The device starts taking measurements immediately as soon as it is turned on. The first result is displayed in 10 sec.

To cycle between the modes press SET: Diagnostic Mode, Received Dose, CPM (clicks per minute scale) **OK**.

The device takes measurements automatically. In case of error, the display will show ERR.

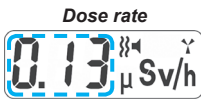

**!** To get optimal results (lowest margin of error) wait for the **n** symbol to appear.

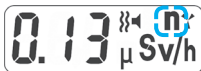

### Turning OFF

Press and hold **OK** for several seconds.

## MENU DIAGRAM

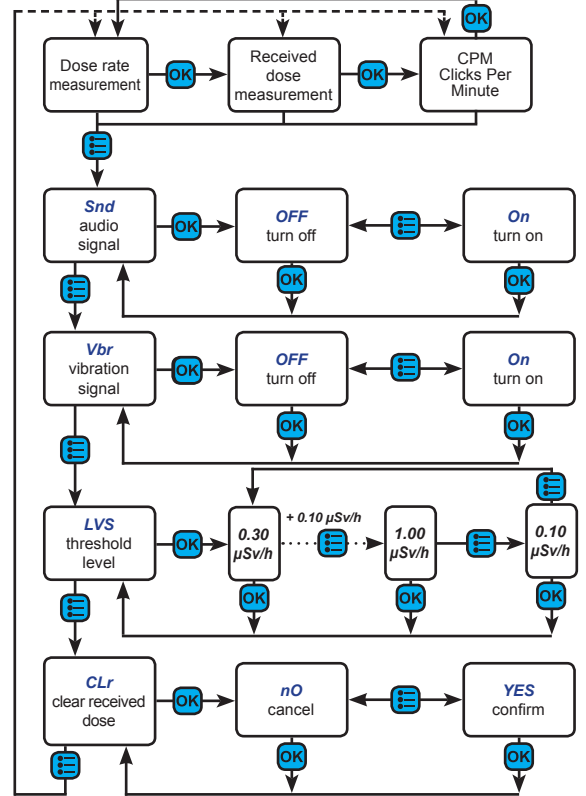





## SETUP

To enter the Menu or to navigate to the next menu option, press **Menu**.

To enter Sub-Menu or to confirm selection, press **OK**.





## Audio Alarm

Turning this function On activates Audio Alarm (beeping) if the unit detects radiation as high as the set threshold level.

1. By pressing  select the menu item **Snd**.
2. Press  and the current state of the audio signal **On** or **OFF** will be displayed.
3. By pressing  select **On** or **OFF** and confirm the selection by pressing .





## Vibration Alarm

Turning this function On activates Vibration Alarm (can work in addition to Audio Alarm) if the unit detects radiation as high as the set threshold level.

1. By pressing  select the menu item **Vbr**.
2. Press , and the current state of the signal **On** or **OFF** will be displayed.
3. By pressing  select **On** or **OFF** and confirm the selection by pressing .





## Setting Threshold Level

If the pre-set value is exceeded, the set alarms will sound and/or vibrate.

1. By pressing  select the menu item **LVS**.
2. Press , and the current threshold value will be displayed.
3. By pressing  select the desired threshold value and confirm the selection by pressing .

## Reset

Sets the counter for received dose rate back to zero.

1. By pressing  select the menu item **CLn**.
2. Press , and **NO**.
3. By pressing  select **YES** and confirm the selection by pressing .

## Data transfer to PC

### System requirements:

- Windows XP, Vista, Windows 7, 8 or later.
- USB port

### Connecting to PC

1. Turn the device ON.
2. Connect the device to your PC via the USB cable provided.

### Software

**RADEX Data Center** - download and install the latest version from [www.QuartaRad.com](http://www.QuartaRad.com).

## TECHNICAL SPECIFICATIONS

Dose rate range	uSv/h	0.05 to 999
CPM range	click /min	0 to 99900
Received Dose range	uSv	0 to 9,990,000
Energy range of registered:		
Gamma radiation	MeV	0.1 to 1.25
X-ray radiation		0.03 to 3.0
Beta radiation		0.25 to 3.5
Margin of error <i>where P - dose rate in uSv/h</i>	%	± (15+6/P)
Alarm (iteration 0.1)	uSv/h	0.1 to 1
Measurement cycle	sec	10
Readings		continuous
Battery, AAA type	pcs.	1
Continuous operation time	hours	3000
Temperature limits	°F	-4 to 122
	°C	-20 to 50
Dimensions	in.	4.3" x 1.25" x 0.9"
	mm	112 x 32 x 23
Weight (without batteries)	oz.	1.4
	g	40

\* On factory settings (vibration signal - OFF, audio signal - ON), natural radiation background.

 The technical specifications of the manual are subject to modification without notice.

..... The results obtained with this device may not be used for official reports.

## How much is dangerous?

Not all radiation is the same, so scientists use the 'sievert' to measure the health risks of radiation.

A one-sievert dose of radiation (SV) would cause immediate radiation sickness. But most radiation doses are much smaller, so you'll see them measured in millisieverts or even smaller microsieverts.

1 sievert (Sv) = 1000 milli-sieverts (mSv/h)  
1 milli-sievert (mSv/h) = 1000 micro-sieverts (µSv/h)

RADEX geiger counters use micro-sieverts (µSv/h)

µSv/h	micro-Sieverts per hour
0.10	This is low, it does not get any lower.
0.21	Pretty normal. Depends on local geology.
0.42	Happens occasionally with no real reason. Just keep an eye on it.
0.83	ALERT - No need to panic, but try to figure out what is going on, stay out of the rain and avoid unnecessary trips.
1.25	Real risk of cancer if exposed for a year.
4.17	Real risk of cancer if exposed for 90 days.

20,000 Annual limit for Nuclear Plant Workers.

100,000 Annual limit for Fukushima workers.

Sievert calculations based on Cesium-137 isotope.

Additional Information and Tech Support

[www.QuartaRad.com](http://www.QuartaRad.com)

CE EAC

